

### SKF S71917 CD/HCP4A参数

主要尺寸	d	85	mm	-
	D	120	mm	-
	B	18	mm	-
基本额定载荷	C	46200	N	动载荷
	$C_0$	48000	N	静载荷
疲劳载荷极限	$P_u$	2040	N	-
可达转速	Grease	14000	r/min	-
	Oil-air	-	r/min	-
重量	重量	460	g	-
型号	型号	S71917 CD/HCP4A	-	-

### SKF S71917 CD/HCP4A图片

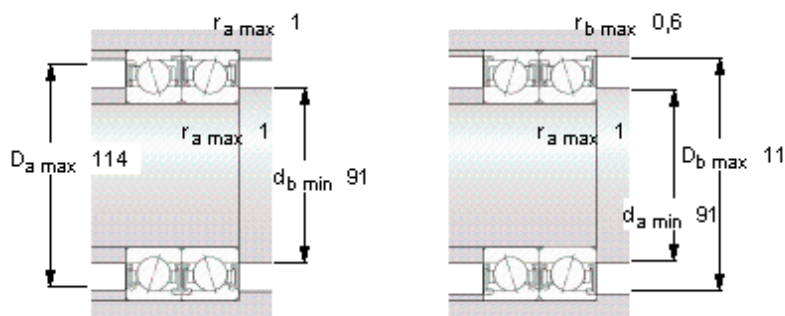
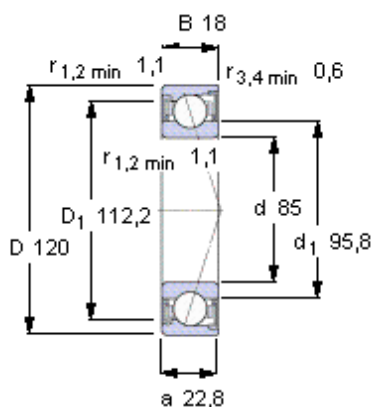

**Ball diameter** 11,112

**Number of balls** 25

#### 未安装时的预载荷 [N]

背对背配置，面对面配置

预载荷等级

A	B	C	D
170	340	680	1360

#### Static axial stiffness [N/μm]

(guideline value)

预载荷等级

A	B	C	D
99	135	191	279

#### Reference grease quantity [cm<sup>3</sup>]

$G_{ref}$  -

#### 计算系数

for equivalent bearing load

$f_0$  16,2

for preload in mounted bearing sets

$f$  1,2

$f_1$  1

$f_{2A}$  1

$f_{2B}$  1,07

$f_{2C}$  1,12

$f_{2D}$  1,18

$f_{HC}$  1,04

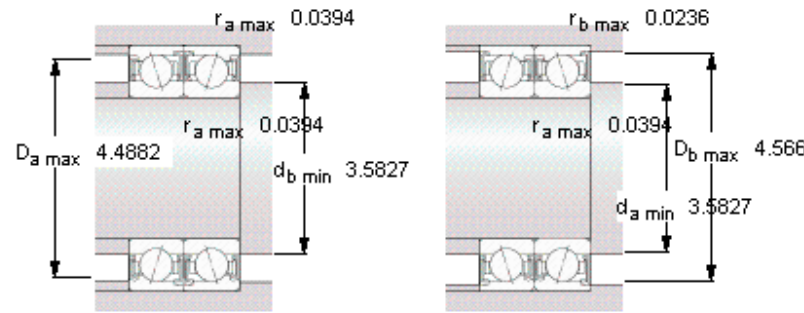
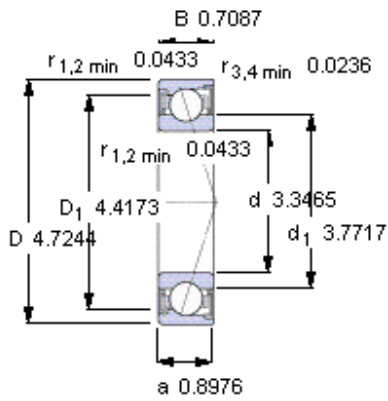

**Ball diameter** 11,112

**Number of balls** 25

**未安装时的预载荷 [N]**

背对背配置，面对面配置

预载荷等级

A	B	C	D
170	340	680	1360

**Static axial stiffness [N/μm]**

(guideline value)

预载荷等级

A	B	C	D
99	135	191	279

**Reference grease quantity [cm<sup>3</sup>]**

G<sub>ref</sub> -

**计算系数**

**for equivalent bearing load**

f<sub>0</sub> 16,2

**for preload in mounted bearing sets**

f 1,2

f<sub>1</sub> 1

f<sub>2A</sub> 1

f<sub>2B</sub> 1,07

f<sub>2C</sub> 1,12

f<sub>2D</sub> 1,18

f<sub>HC</sub> 1,04